

# Tech Notes - Proto:Scale and FINE Scale

TN-1.1.1

A Guide

Published by the National Model Railroad Association

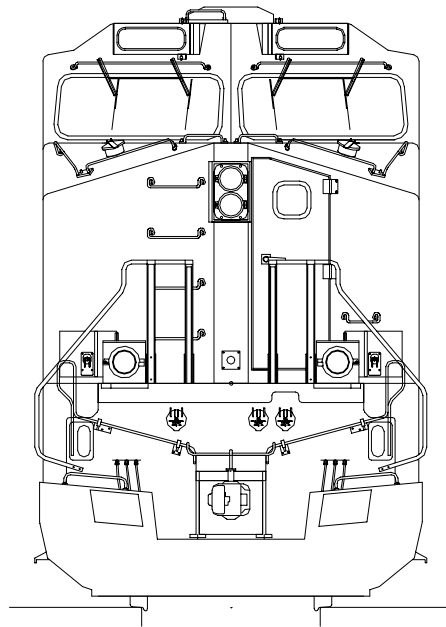

Supplement to NMRA Standards S-3.1 and S-4.1

Published October 31, 2003

## Table of Contents

### **Acknowledgements**

### **Introduction**

Letter of Introduction

### **Section 1 – Identification**

Notation for Labeling

### **Section 2 – Technical Reference 6-2001 and 10-2003**

Spreadsheet

Derivation of Standards

### **Section 3 – Wheel Contours**

Symmetrical AAR Modeled Profile

Optional Profile Compound Face Radius

### **Section 4 – Minimum Radius and Track Gage**

General Considerations

Radius Constraints Tables

Self Guarding Frogs Dimensions

### **Section 5 – Organizations**

¼" AAR Enthusiasts – Proto:48

National Association of S Gaugers – Proto:64

Proto:87 Special Interest Group

Proto:64n42 – New Zealand Narrow Gage

N and Nn3 Fine scale

## Acknowledgements

The NMRA and the Proto and Fine Scale modelers and communities are deeply indebted to a number of pioneers and key individuals for bringing the sanction and endorsement of high fidelity Proto and Fine Scale modeling standards.

In 1985 the TR1-85 report led to the creation of the RP 3 and RP 4 Proto and Fine scale publication based on the RP-25 wheel contour. This effort provided interchange and reliability in solving dual gage interchange for several scales where the standard gage specifications were less refined than the narrow gage specifications. The present ever increasing adoption of the RP-25 wheel profile has improved dramatically traditional scale modeling practices.

A large measure of the success for the TR1-85 and the RP 3 and RP 4 publication was due in large part to the leadership and management of Randy Wilson. Mr. Wilson, served for over a decade on the NMRA Technical Department as Chairman for Proto and Fine Scale mechanical standards and was the author of the TR 6-2001. The Proto Community within the NMRA is deeply indebted to Randy Wilson for his insight and service.

The 1966 Model Railway Study Group (MRSNG) was a major milestone in high fidelity model engineering. A number of individuals who have participated in the review and development of these NMRA Proto and Fine Scale Standards were a part of that landmark effort. Additionally, the Nn3 modelers have developed and practiced a set of high fidelity fine scale practices and standards, which allows for remarkable Fine:N and Fine:Nn3 scale fidelity to be presented as optional FINE scale standards.

I want to express explicit appreciation and acknowledgement for the help and assistance of the following individuals in bringing these Proto and Fine Scale Standards to the Model Railroading Hobby; **Randy Wilson, Rutger Friberg, Roger Miener, Andy Reichert, René Gourley, Russ Elliott, Peter Ross, Keith Norgrove, Jan Frelin, Earl Tuson, John Brouwer, Gene Demling, Andrew Webster, John H. Wright, Peter Thomin, Sam Clarke, Rich Weyand, Thomas Knapp, Brian Barnt, and Stan Ames.**

Edward N. McCamey  
October 31, 2003  
NMRA Technical Department  
Proto and Fine Scales Coordinator

## Introduction

Proto:Scale and Fine Scale is the final frontier in the world of model railroading track and wheels. It represents the culmination of over 45 years of study and development of a track and wheel system that virtually replicates the prototype American railroads in every detail.

Based on the Association of American Railroads (AAR) wheel contour, the measurements are directly scaled from AAR specifications. Much of the early effort was labeled Finescale and one of the first extensive studies recorded was that of the Model Railway Study Group (MRSNG) in Great Britain founded in 1966. Their efforts subsequently led to the proposal of Proto:87 and other track systems in synchronization with then popular American model scales. Coincidentally, during the time of this development in Europe, various American groups were engaged in parallel development and arrived at near identical figures and conclusions.

In the United States, the most organized effort occurred in the 1960's, led by pioneers such as Bob Brown, Bill Clouser, Cliff Grandt and Lee Klaus, among others. Much of this effort centered on using AAR wheel profiles and track gage in 1:48 scale where ¼" equals one scale foot. It was called ¼"AAR at that time.

In the 1980's, the ¼"AAR movement began slowly building again, gaining the recognition of NMRA President Paul Shimada, who authorized the formation of a Technical Department Committee 636, designated Finescale at the time, in 1985. The committee was chaired by R.B. "Randy" Wilson. At the O Scale West Convention held in San Mateo, California the following year, an ad hoc committee agreed to the name Proto:48, unaware that the same name had been proposed back in 1975 by the Protofour Society in Great Britain. With that single change, both Proto:48 and soon, Proto:87 and Proto:64 began a grass roots build-up. During the years since then, several iterations of Large Scale have come forward. In 1996, at the NMRA National Convention in Long Beach, California, Technical Department General Chairman Ron Gaines directed Randy Wilson to develop a comprehensive package of the organized Proto:Scale groups for presentation as full Standards to the NMRA membership. Unfortunately, Gaines passed away unexpectedly before the proposal could be presented.

The proposal came to fruition in 2001, after considerable re-evaluation and a new engineering paper, Technical Reference 6-2001 – Proto:Scale and Fine Scale. Using this spreadsheet, any scale imaginable could simply be typed in and the entire track and wheel system would be created instantly. Once all of the Special Interest Groups (SIG) representing Proto:87 through Proto:48 had reviewed the results, they all signed off on the numbers and the proposal went to the NMRA Board of Trustees. By October of 2003, additional details and considerations were developed and tested based on comments and suggestions provided following the NMRA public posting of the proposed new standards.

This Track and Wheel system is totally interdependent, just like the prototype. For that reason, things like the exact wheel contour and railhead radius begin to enter into the picture like never before. For the first time in its history, the NMRA will provide not only all of the minimum and maximum values for track and wheels, but values for what is considered an optimum wheel and for turnout "target" values as well. Thus, modelers and manufacturers alike will not have to guess at what the best set of numbers should be for good running characteristics.

Does Proto:Scale actually work? That question has been answered long ago as a resounding “Yes!” Effectively the same tread profile was used by the pioneer efforts of the Protofour Society, the wheelsets of Grandtline Products began a de facto standard in 1963 for On3 modelers that lives on today and in Proto:48, the total number of wheelsets sold by different manufacturers is estimated at over 60,000 units. There are operating layouts around the world in each of these scales.

Will Proto:Scale replace existing scale track and wheel systems like HO, S and O scale? No, there will always be a place for HO and others, just as O scale did not replace O Hi-Rail and Tinplate modeling. If anything, many classic track and wheel based movements seem more robust than ever.

The other reason Proto:Scale will not replace traditional track and wheel systems is that it isn't for everyone. By its very nature, the adherence to the prototype means that curvature of track must follow a larger radius than many traditional layouts and modules do today. There are exceptions when the equipment is carefully modified, but the rule is to increase minimum radius to a more prototypical value, not just for operation but for the fidelity to scale and appearance that most Proto:Scale modelers are seeking today.

Also, in the first stages of commercial development, the cost is greater than traditional HO and other systems. That will change rapidly as time goes by and more manufacturers see the financial benefits of supporting the new Standards.

Modelers who choose to build their own will be pleasantly surprised to find that Proto:Scale trackwork is no different in degree of difficulty than hand laying traditional trackwork. The secret is in the judicious use of track gages to build in accuracy. Other than that, all the same rules apply.

Those who aren't sure about whether to forge ahead can try modifying one or two models for use on a module or layout without an intense commitment. But be warned, once you see the beautiful difference, you will be hopelessly hooked.

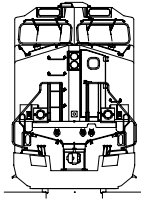

## Letter of Introduction

# National Model Railroad Association

Proto: Scale Committee 636

By Randy Wilson - July, 2001

## A Brief History

While carefully thought out and executed, the design of the National Model Railroad Association did not scale out to prototype. This was due to the use of the NMRA Recommended Practice RP-25 Wheel Contour and the resultant Track and Wheel Standards based on Technical Reference paper TR1-85.

The TR1-85 paper was a milestone for model railroading and made a whole era of standardization possible. It was very literally designed around the RP-25 wheel contour. Unfortunately, the fatter tread and wide tire width of the RP-25 wheel generates some number values that are unprototypical. Also, it is important to realize that engineering tolerances were added to some of the dimensions, to make up for the manufacturing capability of the day.

TR1-85 serves as the primary validation for the former RP 3 and RP 4 data identified for the Fine Scales. The Fine Scale HO is intended to support dual gage interchange with the HOn3 standards and is included now as part of the S3.1 and S4.1 Proto and Fine Scales Standards as applied with a note OPTION Fine Scales. Proposed S3.2 traditional HO scale track standards will, when fully compliant, allow interchange with the FINE Scale HO S4.1 wheels. Best reliability for Fine Scale HO occurs when the Track (S3.1) and the Wheels S4.1 are used together. Use of Fine Scale HO S3.1 track allows for direct interchange in dual gage service with the traditional HOn3 S3.2 standards. The Fine Scale N and Nn3 OPTION presented in the S3.1 and S4.1 Proto and Fine Scales Standards is specifications adopted from over 30 years of actual practice by the 2mm Scale Society, with gage dependency dimensions adjusted for N and Z Scales gages.

Manufacturing capability is an important part of the model railroad industry because our hobby requires fairly close tolerances for both track and wheels. In manufacturing, we are looking at the ability to machine metal wheelsets or to build plastic injection molds for both wheelsets and sectional track. Currently, the majority of modelers in any of the Proto:Scale sizes prefer metal wheels for appearance sake. But Proto:Scale plastic wheelsets will eventually come into use.

Here is the crux of the manufacturing issue; tighter tolerances mean higher cost. Making an injection mold to plus or minus .005" (0.127mm) precision will cost less than .001" (0.025mm) precision. The companies that can produce these higher levels of precision make medical and high tech industrial molds for six to ten times the price that model railroad manufacturers can afford to

pay to bring most of these products to market. If you doubt that, just look at the number of manufacturers of rolling stock and compare that to the number of track manufacturers. If a boxcar door is 0.005" off, the train won't go on the ground.

### **About the New Proto: Scale Values**

In an effort to create a simplified method of dealing with all of these variations, certain assumptions had to be made in order to build a system.

Foremost in thinking about Proto:Scale is the assumption that Association of American Railroads standards will be used. As we will see later, some small concessions are made to address the manufacturing tolerances we have just mentioned.

If we are going to use AAR standards, we should use the latest standards because the industry has not stood still and we shouldn't either. If we don't do that, we have to decide when we should draw the line on standards chronology. Should it be 1935, when most of the key dimensions for today's wheels were set, or should it be 1990, when the new AAR-1B profile was approved. The answer is that we are going to take into account many of these developments to create the model. A second criteria that meshes with this need is that, in Proto:48 for example, there were over 40,000 wheelsets produced before Proto:48 was even approved as a Recommended Practice by NMRA.. We have to insure that the numbers we create will "grandfather" these wheelsets in use.

Another issue is the generous gage widening allowed by TR1-85. That widening was implemented to overcome the very unrealistic minimum radius used on most model railroads of the day. It also increased the tolerance to manufacturing variances of the day. It's important to realize that TR1-85 didn't create these wider specifications; it simply continued the time-honored practice of having them. With Proto:Scale, we assume that the modeler who wants more prototypical appearance in the track and wheels is also likely to use more prototypical radius of track work. For that reason, the unrealistic gage widening has been abandoned.

Fortunately, the AAR standards include tolerances that scale down to our models very nicely. It isn't just the model railroad that ends up with track and wheel variations. Real railroads deal with these same issues every day. This is the most important thing to understand about why Proto:Scale works. It is a reduction in scale of a concept that has been tested and improved for over one hundred fifty years.

### **The Federal Railroad Administration**

The Federal Railroad Administration was created pursuant to the Department of Transportation Act of 1966 and represents consolidated government support of the railroad industry since sunseting of the Interstate Commerce Commission in 1996. The FRA uses a track rating system of Class 1 through 9, with 9 being the highest rated at 200 mile per hour. Various standards apply to these different tracks. The value chosen for Proto:Scale is from the Class 6-9 range for Track Gage Widening. This is the strictest tolerance and highest speed rated group.

### **A Closing Perspective**

Over the years, many different systems have been promoted for different scales. If history has proven anything, it is that this system of track and wheel relationships has a surprisingly high fault tolerance. It is also important to remember that the majority of track in Proto:Scale so far has been hand laid with all the attending variations that the process generates. A human hair averages three thousandths of an inch (0.0762mm) thickness. Most of the variations observed from existing systems are within this limit. Not hitting these numbers will not preclude successful operation of a model railroad. They may increase the likelihood of derailments but so does dust on the track. Our common ground is that we all value the beauty of track and wheels that look totally authentic.

The Proto:Scale information provided here was submitted to the National Model Railroad Association for action at the July, 2001 National Convention in St. Louis, Missouri.

Randy Wilson - Chairman

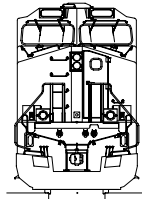

**Information updated and corrected July – October 2003 based on comments from public posting of proposal.**

Edward N. McCamey – Proto and Fine Scale Coordinator



## Section 1 – Identification

For the first time ever, the NMRA will be promoting and selling products that share a common scale such as 1:87 and a common track gage such as .649" (16.48mm) in both Proto:87, HO Finescale and traditional HO. For that reason, proper identification of the products on a retailer's shelf will become critical to allowing the modeler to make the correct buying decision.

For that reason, certain conventions must be observed for everyone's benefit. For all classes of equipment and components the use of 'PROTO' and 'FINE' with an identification of Scale Ratio and notation as reference to "NMRA Sx.1" will refer to items produced under these Proto and Fine Scale Standards.

The identification of Proto:XX (NMRA Sx.1) will explicitly refer to the standards and tolerance ranges as published in Standards S3.1 and S4.1.

Examples:

Trackwork compliant components would provide:

Frog Casting Code 75 - Proto:87 (NMRA S3.1)

Guardrail Modification Kit Code 83 - Proto:48 (NMRA S3.1)

Wheelset compliant components would provide:

Wheelset 33" Code 64 - Proto:87 (NMRA S4.1)

Driver 16 Spoke 52" Code 115 - Proto:48 (NMRA S4.1)

The use of only the Proto:xx without the (NMRA Sx.1) is allowed, but full use of the "NMRA Sx.1" notation is encouraged.

The identification of Fine:xx (NMRA Sx.1) will explicitly refer to the standards and tolerance ranges as published in Standards S3.1 and S4.1.

Examples:

Trackwork compliant components would provide:

Frog Casting Code 55 - Fine:HO (NMRA S3.1)

Guardrail Modification Kit Code 40 - Fine:Nn3 (NMRA S3.1)

Wheelset compliant components would provide:

Wheelset 33" Code 88 - Fine:HO (NMRA S4.1)

Driver 16 Spoke 52" Code 55 - Fine:N (NMRA S4.1)

The use of only the Fine:xx without the (NMRA Sx.1) is allowed, but full use of the "NMRA Sx.1" notation is encouraged. Present commercial practice of "semi-finescale" labeling does not warrant compliance (though may be in compliance) with the Sx.1 standards. Fully compliant products should provide the identity label with the "Fine:xx" notation. Use of "semi-finescale" labeling is reserved for manufactures who elect to provide improved fidelity for SX.2 (traditional standards) intended products, but not compliant with Fine Scale Sx.1 standards.

## Section 2 – Technical Reference 6-2001 and 10-2003

### About the Spreadsheet

A new spreadsheet has been created that allows for the scale to be entered and all of the required values to be automatically generated as a result. There is one for Standard Gauge and one for 3 foot Narrow Gauge. This is much like the TR1-85 spreadsheet, but it is built around AAR specifications instead of the RP-25 wheels. The worksheets shows the formulas used.

The column labeled Scale Ratio is column D in the spreadsheet and the row numbers are listed to the right of the data columns. By entering the formula in the appropriate place in column D, all of the values will calculate by entering the scale, such as 87.1 for HO (yes, that's right, it isn't 1:87, it's 1:87.1), 48 for Proto:48 and so on. The Narrow Gauge spreadsheet works the same way with no special number except the scale ratio. Notice that no reference is made to scales by the old fractional values such as 1/4" or 3/16". That is part of what Proto:Scale was meant to eliminate.

### Individual Values

#### S3.1 Track

Gmin - The fundamental Track Gage Minimum defined by the AAR at 4'-8-1/2" or 56.5". While FRA regulations allow a minimum of 4'-8" or 56" exactly, model railroading has never used less than the first number.

Gmax - This value is defined by the gage widening specification (1.25") of the Federal Railroad Administration for Class 6 track which is speed rated for 110 mile per hour through Class 9 which is speed rated for 200 mile per hour.

Cmin - Check Gage Minimum is defined for FRA Class 5 and 6 track.

Cmax - Check Gage Maximum is determined by combining Back-to-Back Maximum with Flange Maximum.

Fmax - Flangeway Maximum determines the amount of support for the wheel at the frog of a turnout. At this point, the wheel must span across the effective distance of two flangeways in order to avoid dropping to the flangeway floor. In order to provide enough tread on the railhead, the Flangeway Maximum limits this gap to the nominal prototype value of 1.875". After subtracting both the rail head radius and outer wheel radius, the remaining tread still provides .625" (15.9mm) of support on the prototype.

Hmin - Flangeway Depth Minimum defines the distance to the floor of the Flangeway. For modeling purposes, it is limited to equal Dmax, the Flange Depth Maximum set in Standard S4. To limit the possibility of wheels dropping between the effective distances of two flangeways noted in Fmax, this dimension should be held as close to Hmin as possible.

Smax - Span Maximum is determined by taking the Gauge Minimum minus two times the Flange Maximum. Note the 52.938" AAR minimum Back-to-Back is slightly larger than the 52.750" Span Maximum which prevents the Back-to-Back wheel dimension from binding across the Span.

Pmax-m - Point Spread Maximum (mechanical) is specified by the American Railway Engineering Association at 4.75". While the prototype has varied from 3.5" to 5.25" gap between the stock rail and point rail in the past, this specification is current as of 1985.

Pmax -e - Point Spread Maximum (electrical) is no longer required. Because the 4.75" mechanical gap will clear the back of a wheelset by 1.094" in a worst case scenario, there is no longer a need for a separate electrical specification. This is because we are using real railroad practice instead of defining an absolute maximum envelope for error, as TR1-85 does.

#### **S-4.1 Wheels**

Kmax - Wheel Check Gage Maximum is equal to Track Check Gage Minimum (Cmin).

Kmin - Wheel Check Gage Minimum is equal to Back-to-Back Minimum (Bmin) plus Flange Width Minimum (FMin).

Bmax, Bmin - Back-to-Back Maximum and Minimum are both defined by AAR specification for all wheelsets per the 1997 Car & Loco Cyclopedia, page 780.

Nmax - Tire Width Maximum is defined by the AAR specification for Wide Flange Wheels at 5.719".

Nmin - Tire Width Minimum is defined by the AAR specification for Narrow Flange Wheels at 5.500".

Tmax - Flange Width Maximum is defined by the AAR specification for Wide Flange Wheels at 1.375".

Tmin - Flange Width Minimum is defined by the AAR specification for Narrow Flange Wheels at 1.156".

Dmax - Flange Depth Maximum is set at 1.300" as an upper limit for manufacturing tolerance. The actual condemning limit set by AAR is when 0.750" (3/4") wear occurs and increases the effective flange depth to 1.750". A wheel that has reached the maximum allowed flange depth is badly cupped and does not represent an engineered profile. For modeling purposes, we need to have a smaller upper limit because the Standard we produce becomes an upper limit for manufacturers. The wheel geometry becomes radically different between the flange throat radius and flange top front radius when we allow model wheelsets to reach the prototype-condemning limit. We want the variance from one wheelset to another to be minimized and this limit allows a reasonable amount of manufacturing tolerance to occur in each scale. This value also preserves the important "grandfather" clause mentioned earlier for the huge volume of 1/4" AAR wheelsets produced prior to NMRA approval of Proto:48, as well as a host of narrow gauge wheelsets in the same realm.

Dmin - Flange Depth Minimum is set at 1.000", the AAR specification for both Wide Flange Wheels and Narrow Flange Wheels.

Wheel Gage Maximum and Minimum are listed as an arithmetical test of the Back-to-Back and Flange Thickness values in the spreadsheet.

Railhead Radius is a new specification based on AREA specifications for rail that match the AAR wheel profiles. A railhead with perfectly square edges decreases the effective track gage to less than the gage minimum requirement. A railhead with excessive edge radius effectively widens the track gage and may allow for the wheel to drop between the effective double flangeways listed under Fmax in a worst-case situation.

While certain specifications such as Back-to-Back minimum and Span maximum suggest that an interference fit is acceptable, that is not the case. Turnout dimensions are provided in the Proto:Scale Tech Notes that specify the target or optimum turnout value, thus avoiding guesswork or problems.

## Derivation of Proto:Scale Standards

**Introduction.** The prototype railroads have continuously advanced standards for interchange with track and wheel relationships for over a century of progress. Prototype physics and engineering are based on several characteristics and principles.

- **Mass and Weight.** Mass with attending center of gravity plays a key role in the placement of the track; issues of spiral easements, super elevation, and grade are restrictive track and equipment design elements affected by prototype mass. The prototype places many tons of applied weight on each individual wheel (see equalization below) riding on the railhead while in motion.
- **Equalization and Compensation.** The Prototype equipment has engineered chassis and rolling components using leverage and springs to provide a near equal distribution of the weight (equalization) and a smoothing cushion of springing (compensation) applied to the wheel to rail relationship.
- **Engineering Fit and Clearance.** The prototype has full size physics as a scale to provide relative mass production and maintenance capabilities which provides for reliable wheel to axle perpendicularity, bearing and mechanical fit without bind, and a rolling clearance of the track and wheel relationships.
- **Track and Wheel Component Profiles.** The prototype has developed and engineered several concepts, which provide reliable operation. While specific prototype practices and dimensions evolve over time and by specific railroads, the concepts are engineering practices that remain the same.
  - **Track** railhead has a large radius crown (usually as much as 2 to 3 times the rail height) and the railhead to running railhead side has a radius edge to closely match the wheel root flange radius.
  - **Wheels** have a tapered wheel tread, a root flange radius, and a flange profile which is not symmetrical, but has a large radius facing flange profile (often as much as 1-1/2 to 2 times the flange apparent thickness) that provides a gentle easing of flanges on curves where the flange is 'attacking' the railhead side at an oblique angle. Further, because of the root radius relationship to the crowned railhead, prototype profiles result in an "Effective Flange (EF)" size that is the measurement of the railhead running side to the back of the wheel when the wheel tread rests at the closest point, yet not riding on root radius and still maintaining wheel tread contact.

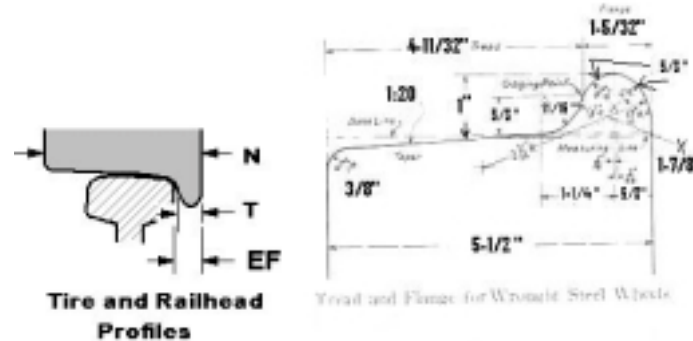

- Together the track and wheel component profiles provide a perfect theoretical (and practical actual) centering of wheel sets to the parallel rails while in motion, guiding the flanges away for the railhead, and provides for stabilization under rolling conditions.

**Modeling Physics.** When Prototype dimensions and specifications are scaled for modeling, the elements of mass and weight do not scale linearly, but rather follow cubic or root rules. Thus, the easements and super elevation are not required, weight in models is dramatically less (proportionately) but the model physics thus have less tracking capability. Design and engineering, particularly in smaller scales, does not provide the flexibility and smoothing that equalization and compensation provides for the prototype. Models can and do have some measure of flexibility, but the critical need for equal weight distribution (especially when there's MUCH less to equalize) becomes very demanding to design and implement. When prototype machine fit is scaled down to small scales, the result is no longer a running capability, but is now a forced or interference fit. Clearances on the prototype can in the worst-case Class 1 FRA (a 5 MPH restricted condition) approach a mere 3/16 of an inch. When that clearance is scaled to smaller scales, the resulting clearance of critical running components will approach or now become a binding fit – certainly not a rolling clearance. With several tons of weight on a rolling prototype wheel, 3/16-inch clearance is sufficient to allow operation, but in scale ratios (especially smaller scales above a ratio of 1:52), the clearance becomes a very near a 'thumb' press fit! When prototypical dimensions are scaled directly (within capability of reasonable model production), the profiles of the modeled track railhead and the wheels now need to match the characteristics of the prototype to extract the same physics and engineering relationships that are of benefit. Traditional scale modeling has relaxed and made optional the wheel tread taper and the root flange radius, as well as the railhead side radius and the crowned top. The relaxation is made up by traditional model wheels being larger in width (sometimes more than 2 times the width) and flanges often as much as 4 times the prototypical representation. With adoption of prototypical scaling of dimensions for Proto:Scale modeling, with modest compromises (some very modest practical limits as addressed below for mechanical fit and model clearance), the modeled components (flanges, tire width, flangeways, railhead design, etc.), now have a distinct modeled size and the physics of operation are in the modeled real world. The compression of curvature and the divergence of track in the model turnouts necessary because of space constraints indicate that the long wheelbase locomotives will have to have equalization and compensation in vertical and lateral movements to keep those tiny-modeled real world flanges on the railhead. The engineering of modeled trackwork requires the track levelness, gage rail parallel limits, and joint kinks of modeled track bears a direct physical relationship of engineering limits that is far more demanding than traditional model practices in implementation as the model scale gets increasingly smaller. These factors, taken as a whole,

November 15, 2003

mean that Proto:Scale modeling standards need adjustments from a purely direct linear scaling of prototype standard dimensions with the use of constants for modeled real world physics and practical miniature engineering limits. The amount of constant value adjustment is mathematical and has been found to be particular to the scale ratio reduction of the prototype dimensions.

“Build matching track. You will never get good running with wheels and track that are incompatible.” Keith Norgrove

**Modeling fit and clearance as Proto:Scales constants.** Engineering of moving components has two basic characteristics that affect the dimensional standards required for operating small replications of railroad prototypes. The following terms are used for Proto:Scale formulas; FIT and SLIDE.

- **FIT** is the need to provide sufficient difference to allow movement and adjustment of smaller connected components that could prevent interference of functionality to occur. Several critical extreme limits of prototype specifications are adjusted by a constant of FIT by reducing or adding to the characteristics of MAX and MIN at the extreme limits of specification. These relationships adjustments of FIT also assist in the accommodation of certain other hard to manage miniature component requirements, such as wheel wobble issues magnifying the apparent size of flanges. FIT is set at a nominal .001 inch for all scales smaller than 1:68. The formulas where the FIT constant is applied to the prototype specifications are:
  - Subtracted from Track check gage minimum to maximize clearance capacity in modeled compressed curvature of long wheel base multi-axle wheel sets in traversing the curved route through the frog.
  - Added to Track flange way maximum at frog to maximize clearance capacity in modeled compressed curvature of long wheel base multi-axle wheel sets in traversing the curved route through the frog and assist in meeting the K-crossing guardrail symmetry objective.
  - Subtracted from Track flange way minimum (at guard) to maximize clearance capacity with Track span gage and assist in meeting the K-crossing guardrail symmetry objective
  - Added to Wheel back-to-back minimum to maximize clearance capacity with modeled wheel sets to support track span gage clearance and help limit range of wheel check gage to assist in meeting frog point clearance requirements. Modeling physics does not require the far greater range of specifications due to component wear characteristics required on prototype components.
  - Added to Wheel tire width maximum to maximize clearance capacity with modeled curve compression and assist support of wheel set across the frog railhead gap. Further assists in supporting self-guarding frog capability.
  - Added to Wheel tire width minimum to maximize clearance capacity with modeled curve compression and assist support of wheel set across the frog railhead gap. Further assists in supporting self-guarding frog capability.
  - Subtracted from Wheel flange width minimum to maximize clearance capacity in modeled compressed curvature of long wheel base multi-axle wheel sets in traversing the curved route through the frog and assist and clearance capacity with modeled wheel flange manufacturing capability. Modeling physics does not require the far greater range of specifications due to component wear characteristics required on prototype components.

- **SLIDE** is the clearance factor that allows for non-connected components that requires a running clearance and to provide in the modeled scale sufficient space to clearly prevent direct interference bind. There is also the need to provide some additional accommodation in managing compression of track curvature and the constrained practical capability for designing and implementing flexibility of chassis needed to provide full equalization and compensation. SLIDE is set at a nominal .001 inch for all scales smaller than 1:24, and is increased to .002 on Proto:Scales smaller than 1:68. The formulas where the SLIDE constant is applied are:
  - Added at Track flange way minimum at frog to maximize clearance capacity in modeled compressed curvature of long wheel base multi-axle wheel sets in traversing the curved route through the frog.
  - Subtracted from Track Span maximum to maximize clearance capacity in preventing binding of wheel set on span gage rail components and assist in meeting the K-crossing guardrail symmetry objective.
  - Subtracted from Wheel check gage maximum to maximize clearance where track check gage minimums are established in crossing track work and assist in meeting the K-crossing guardrail symmetry objective.
  - Added to Wheel tire width maximum to establish maximum range to support consistent nominal range allowing for self-guarding frog adoption.
  - Subtracted from Wheel flange width maximum to provide clearance capacity in modeled compressed curvature and additional binding clearance of long wheel base multi-axle wheel sets in traversing the curved route through the frog.

**Note on Wheel Width and use of Self-Guarding Frogs.** U. S. prototype practice has increasingly begun to employ the use of self-guarding frogs for turnouts and at some selected special diamond crossing configurations. The interchange dimensional limits of prototype wheel widths and profiles allows for this option reliability. For modeling in the Proto:Scale, the opportunity to model self guarding frogs is dependent on a same level of limits for the constraining dimensions. As the wheel enters the frog, the flanging guide presses on the face of the wheel to assure the wheel flange moves away and clears the point, and at the same time, there must be sufficient clearance such that the back of the wheel is not forced into a bind against the corresponding wing rail guide. For this relationship to be maintained, the wheel must be at a sufficient minimum width to allow the flange guide to move the flange away, and also limited in maximum width so as to prevent the wheel back to wing rail binding. The flangeway dimensions must of necessity also be fixed to a limit tolerance of constraints. The developed Proto:Scale dimension standards as applied to the wheel widths (and the limits of the flanges), as well as the flangeway minimum and maximum, using the applied constants factors of FIT and SLIDE, does provide interchange and reliable operation for modelers to employ the option of self guarding frogs.

**Rules validating the Proto:Scale Track and Wheel relationships.** Rules of railroad track and wheel relationships (equally for prototype and model) have been engineered and refined for over a century of practice and implementation. Sound engineering practices have established the following basic rules required for operational railroad components to provide reliability, safety, and interchange. Note that the formulas express as a mathematical relationship pertinent to interchange and allows for a positive or zero value, but a slight positive value above zero will, in every case, result in higher reliability of operating characteristics. *All drawings are*

adopted from *Scalefour Digest 1.2, Issue 2, December 1998, P4 Track and Wheel Standards by Russ Elliott.*

1. **Plain track running clearance.** The wheel gage composed of the back to back maximum and both maximum flanges must be less than the minimum track gage to prevent wheel set binding on track. **Formula:  $G_{min} - (B_{max} + 2 * T_{max}) = \text{positive or zero value.}$**

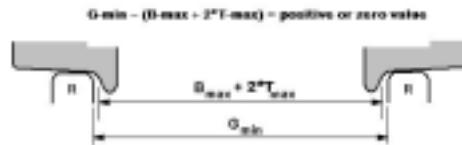

2. **Preventing wrong flange route through frog.** Track check gage minimum value must be less than the wheel set maximum check gage to prevent flange from striking rail points at frog. **Formula:  $C_{min} - K_{max} = \text{positive or zero value.}$**  Note that using a maximum back to back and one maximum flange may cause a the wheel check gage being larger than the established maximum wheel check (K) dimension by a modest amount, thus, the proper setting of wheel back-to-back must be less than the B-max when fitted with T-max flanges. This implies that wheel sets are governed more by wheel check gage specification than by a fixed back-to-back specification, although the back-to-back range is an important specification for span clearances. Only where there is a fixed specific wheel profile having nominal dimensions with tight tolerances (not the case for U.S. prototypes), can reliance on back-to-back be made paramount in establishing wheel set spacing.

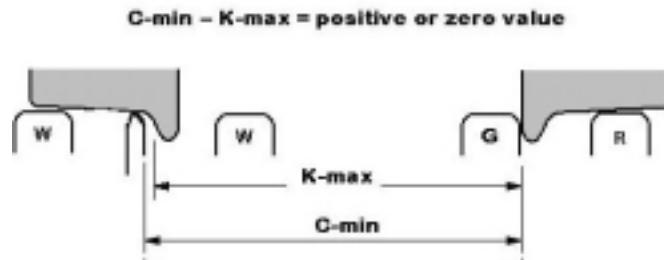

3. **K-crossing (oblique angle) and 3-way wing and guardrail symmetry objective.** The obtuse frogs found in high numbered crossings, in varied slip switches, and complex 3-way (or dual gage) switches, desires (an objective) guardrail symmetry to maintain the route-selected balance supporting reliability and conformity. **Formula:  $G_{min} - F_{max} - C_{min} = \text{positive or zero value.}$**

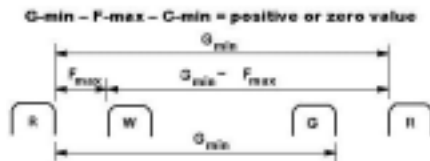

4. **Tire support across frog.** The wheel tire width minimum must be greater than the track flangeway maximum at the frog gap where two flangeways exist to prevent wheel drop into



rail gap. **Formula:  $N-min - 2 * F-max = \text{positive or zero value}$ .** Note that where adoption and use of self-guarding frogs such as adopted in U.S. prototype practice, there is a requirement that the tire tread width maximum be set at a nominal value consistent and close to the range for wheel width minimum.

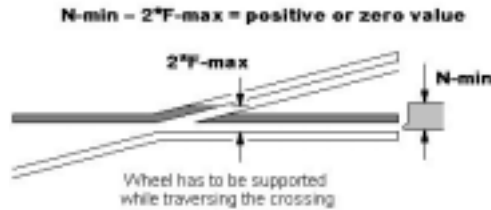

5. **Span clearance.** The guard and wing rail span gage must be less than the wheel set back-to-back minimum to prevent binding of wheel set on span gage rail components.

**Formula:  $B-min - S-max = \text{positive or zero value}$ .**

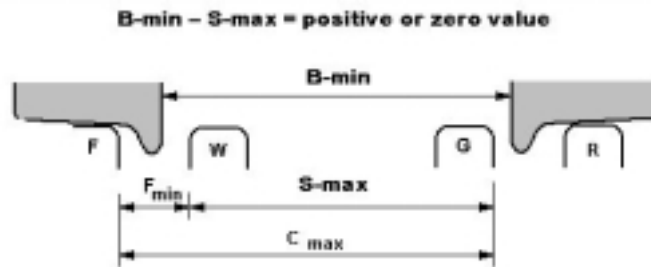

6. **Flange clearance in flangeway.** Track flangeway minimum must be greater than wheel flange maximum to prevent wheel flange binding in flangeway. **Formula:  $F-min - T-max = \text{positive or zero value}$ .** In actual engineering, the flange size is magnified by the reality of "Effective Flange (EF)" because of the wheel to railhead relationship. Note that the frog flangeway at the wing rail to point distance is recommended to be F-max to provide for clearance of long wheel base multi-axle wheel sets traversing the curved route through the frog.

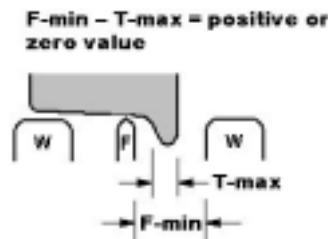

7. **Tire support on gauge-widened track.** The track widening gage maximum allowance must be set to not exceed the worst case wheel tire tread to wheel tire face to prevent wheel sets dropping between the rails. Two applicable formulas:  **$T-min + B-min + N-min - G-max = \text{positive or zero value}$** , and  **$K-min + N-min - G-max = \text{positive or zero value}$ .**

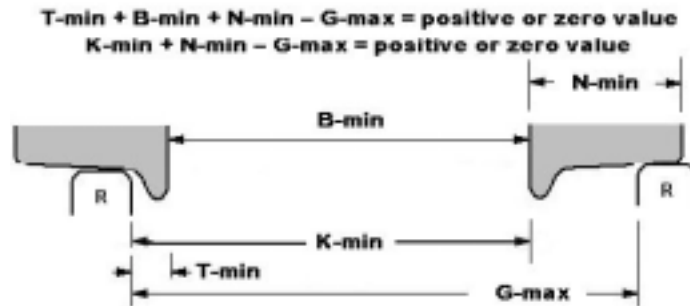

**The Proto:Scale formulas and dimensions.**

“The wheel flange dimensions and the dimensions of the rail profile (these dimensions in combination, define the "effective flange") combine to determine the flangeway width. When the flangeway width is determined, everything else falls into place.” Roger Miener

The actual prototype (U.S. applicable AAR, AREA, FRA) dimensions and specifications and the scaled dimensions and formulas are encompassed in the Proto:Scale Tech Notes spreadsheet. This spread sheet provides a tab for both Standard (56.5”) and Narrow gage (36”) dimensions and a tab for Wheels. The validation formulas are displayed. One needs only to provide the entry input as the scaled ratio for the chosen scale to be proto modeled.

A table of curvature restrictions and capabilities is included with 4 tables is also included. The first table is for a modeled representation with worst case track and wheel gage operated in a traditional model rigid chassis having only operating fit clearances and running on minimum gage track. The next three tables, utilize a Proto:Scale recommended flexibility in chassis providing vertical and lateral movement together with a nominal vs. worst case wheel gage relationship (a realistic and practical implementation). Tables 2 through 4 shows respectively the minimum radius allowable with minimum track gage, nominal widened gage, and maximum allowable widened track gage for a given wheel base. All four tables use prototype wheel base dimensions (and the modeled equivalent) as a data reference.

### Section 3 – Wheel Contours

The AAR wheel profile has several characteristics which does not scale down in smaller scales well and still provide either operational model physics or visual definition for model use. Note that with the true AAR profile, both the facing and the rear flange sections has an integrated large radius joined with the root flange radius and the point radius. The Proto:Scales profiles recommended for the standard is two established and recognized model representations for prototypical wheel profiles.

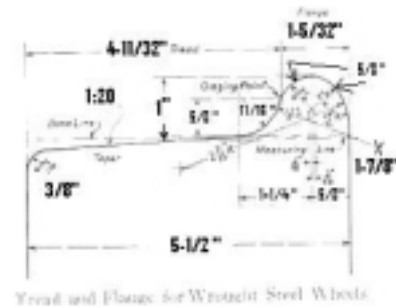

**Prototype AAR Profile**

#### Symmetrical AAR Modeled Profile.

The basic symmetrical AAR modeled wheel profile is a scaled version of the NMRA familiar RP-25 profile with correction and adoption of wheel width and flange sizes matching the prototype numerical data. As previously noted the true AAR profile has both the facing and the rear flange sections with an integrated large radius joined with the root flange radius and the point radius respectively. The modeled symmetrical profile eliminates this complication which serves as no particular benefit when scaled down in typical modeled scales.

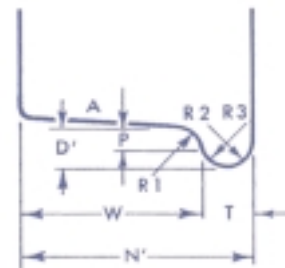

**Model Profile AAR Symmetrical**

Model Profile AAR Symmetrical											
Scale		Proto:87.1		Proto:64		Proto:48		Proto:32		Proto:20.3	
Model Dimension	ID	Min	Max	Min	Max	Min	Max	Min	Max	Min	Max
Tire Width	N	0.064	0.069	0.087	0.092	0.115	0.120	0.172	0.180	0.271	0.282
Flange Width	T	0.012	0.014	0.017	0.019	0.024	0.028	0.036	0.042	0.057	0.068
Tread Width	W	0.050	0.056	0.067	0.075	0.087	0.096	0.130	0.144	0.203	0.225
Flange Depth	D	0.012	0.014	0.017	0.020	0.021	0.026	0.031	0.039	0.049	0.062
Fillet Radius	R1	0.008		0.011		0.014		0.022		0.034	
Tread Taper	A	20:1		20:1		20:1		20:1		20:1	
Gaging Point	P	0.008		0.011		0.014		0.021		0.033	
Flange Back Radius	R2	0.007	0.007	0.010	0.010	0.013	0.013	0.020	0.020	0.031	0.031
Flange Front Radius	R3	0.007	0.007	0.010	0.010	0.013	0.013	0.020	0.020	0.031	0.031

### Optional Profile Compound Face Radius

The 1966 MRSG study developed a model wheel profile based on the British BA275A wheel profile and scaled dimensions for modeling scales. This profile does include a larger face radius to provide additional guiding functionality on sharper compressed curves and serves well in modeled form. Because the BA wheel profile has several dimensions which are actually smaller than US AAR specifications, an alteration of this profile has been made to adjust the resulting functional dimensions to meet the US AAR specification.

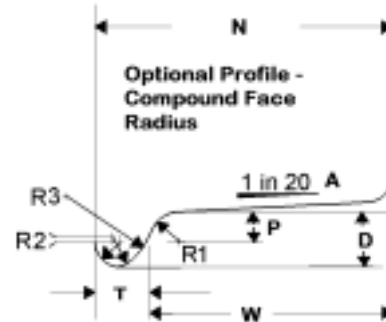

Optional Compound Face Wheels											
Scale		Proto:87.1		Proto:64		Proto:48		Proto:32		Proto:20.3	
Model Dimension	ID	Min	Max	Min	Max	Min	Max	Min	Max	Min	Max
Tire Width	N	0.064	0.069	0.087	0.092	0.115	0.120	0.172	0.180	0.271	0.282
Flange Width	T	0.012	0.014	0.017	0.019	0.024	0.028	0.036	0.042	0.057	0.068
Tread Width	W	0.050	0.056	0.067	0.075	0.087	0.096	0.130	0.144	0.203	0.225
Flange Depth	D	0.012	0.014	0.017	0.020	0.021	0.026	0.031	0.039	0.049	0.062
Fillet Radius	R1	0.008		0.011		0.014		0.022		0.034	
Tread Taper	A	20:1		20:1		20:1		20:1		20:1	
Gaging Point	P	0.006	0.007	0.007	0.010	0.009	0.013	0.014	0.020	0.022	0.031
Flange Back Radius	R2	0.005	0.006	0.006	0.008	0.008	0.010	0.013	0.016	0.020	0.025
Flange Front Radius	R3	0.022	0.025	0.031	0.035	0.043	0.050	0.065	0.076	0.103	0.122

### Wheel Profiles for FINE Scale options.

The FINE scale options use the current RP-25 familiar wheel profile. While finer profiles can be adopted for Fine Scales, at present, the proof tables and validations rely on the TR 1-85 development.

## Section 4 – Minimum Radius and Track Gage

### General Considerations

There exist few if any modelers who have the luxury of space to replicate prototype practices for curves. Given that prototype Class I mainline railroads operate on curves generally in the 3 to 8 degree maximum and tend to want only curves less than 3 degree wherever possible and in model terms these curves represent dozens of feet in radius for even the smaller scales, the practicality is just unrealistic. Modeling will always demand compression.

The choice of Proto:Scales interrelationship of track and wheels replicating the prototype will restrict the amount of compromise and compression available and expect more generous curvature for operational reliability and appearance. However, the carefully chosen specifications for Proto:Scales has introduced very modest visually imperceptible allowances to give the Proto:Scales operating equipment same leverage in reliably operating with compressed curvature. Using the smaller minimum of flange width specifications and assuring the maximum wheel set gage is not exceeded, together with careful gage widening within the specifications provides a measure of forgiveness in negotiating curves and maintaining functionality through turnouts and special trackwork. But note, that gage widening is limited to the point that the railheads are required to support the wheel treads of the Proto:Scales prototypically narrow wheel profiles.

A major issue for prototypes and models is the fixed wheelbase and the designed chassis engineering flexibility. As wheelbase becomes larger and negotiates a curve, the leading and trailing axles will force the wheel flanges against the outside rail and the axle will not be perpendicular to the railhead, thus creating a flange angle of approach or attack that wants to force the wheel to ride up and over the railhead. Gage widening will greatly improve the degree restriction up to a point, but will not completely alleviate the tendency for flanges to derail. In multi axle chassis components the center wheelset flanges will be forced to the inner railhead and the combination will with tight curves create forced interference conditions. Chassis design not only has to have flexibility to provide equalization and compensation to provide weight distribution, but also to allow axle lateral movements, especially in the middle axles so that the wheel base has additional 'bending' through the curve. For steam equipment wheelbases, the connecting rods for the drivers will require some flexibility to avoid binding the lateral action. Just like the prototype, model Proto:Scales steam equipment will need some effort of hinging the connecting rods with forked or lap joints to prevent the lateral action binding.

### Turnout size Restrictions

Another limitation of curvature for large wheel base equipment is the compression allowable for the curving divergent route through a turnout. As the leading and trailing axles split the frog flangeway area, the middle axle wheelsets must still allow for the flange through the frog to not be offset too far so that the flange wants to ride over the wing rail. Turnouts should as a consequence choose to have the maximum allowable flangeway size through the frog. Nevertheless, large wheel base equipment will require larger (gentler) than model normal turnouts for reliable operations. Again, careful chassis flexibility design incorporating lateral axle movement will improve the allowance for maximized options within certain limits.

### Standards Design Provisions

The TR 10-2003 spreadsheet for the Proto:Scales specifications provides several tables of curvature allowance. The tables are based on the wheelset gage and track gage offset difference, the gage widening, and lateral action of middle axle wheelsets. Using geometric versine cord and offset computations, specific model wheelbase and curve allowance is identified for each scale. Proto:Scale modelers can dramatically improve curve compression capability by providing the extra effort in the chassis flexibility. The skills required are more demanding than unpacking a R-T-R locomotive and operating, but are well within the capabilities of most modelers who select Proto:Scales and recognize the extra effort demanded to detail and operate high fidelity equipment.

Typical model equipment design and manufacture has provided relative rigid wheelbase engineering with extra 'slop' for flexibility. Unfortunately, that approach will be unreliable for Proto:Scales because the wheel profiles and flanges do not provide the margin of error that the larger wheels and flanges have provided in the traditional model design.

### The Curvature Tables

The four tables of curvature and wheel base calculations provided in the TR 10-2003 spreadsheet give guidance for the modeler in selecting minimum radius curves and turnout restrictions based on the wheelbase of equipment operated and the degree of chassis flexibility provided.

**Table 1** is a hard rigid chassis, worst-case wheel set and wheel profile, and minimum track gage typical of most traditional model design. Offset allowance available is only that provided as models all axle lateral movement and the difference between the wheel gage and the track gage. This is the most restrictive set of curvature allowance.

Table 1 Most Restrictive									
Wheel Base	Proto:48			Proto:64			Proto:87		
Proto Feet	Model Inches	Off-Set Inches	MIN Curve Inches	Model Inches	Off-Set Inches	MIN Curve Inches	Model Inches	Off-Set Inches	MIN Curve Inches
13	3.250	0.025	52.82	2.438	0.025	29.72	1.791	0.022	18.24
14	3.500	0.025	61.26	2.625	0.025	34.47	1.929	0.022	21.15
15	3.750	0.025	70.32	2.813	0.025	39.56	2.067	0.022	24.28
16	4.000	0.025	80.01	3.000	0.025	45.01	2.204	0.022	27.62
17	4.250	0.025	90.32	3.188	0.025	50.81	2.342	0.022	31.18
18	4.500	0.025	101.26	3.375	0.025	56.97	2.480	0.022	34.95
19	4.750	0.025	112.82	3.563	0.025	63.47	2.618	0.022	38.94
20	5.000	0.025	125.01	3.750	0.025	70.33	2.755	0.022	43.15
21	5.250	0.025	137.82	3.938	0.025	77.53	2.893	0.022	47.57
22	5.500	0.025	151.26	4.125	0.025	85.09	3.031	0.022	52.21
23	5.750	0.025	165.32	4.313	0.025	93.00	3.169	0.022	57.06
24	6.000	0.025	180.01	4.500	0.025	101.26	3.307	0.022	62.13
25	6.250	0.025	195.32	4.688	0.025	109.88	3.444	0.022	67.42
26	6.500	0.025	211.26	4.875	0.025	118.84	3.582	0.022	72.92
Worst case wheel set and hard rigid chassis wheelbase (nominal clearance only)									

**Table 2** is a minimum track gage with nominal wheel gage case, but equipment chassis has incorporated an additional ½ percent of wheelbase lateral flexibility. This table also represents the minimum curvatures expected through turnouts for the given wheel base in use.

<b>Table 2 Restrictive and Turnout Criteria</b>									
<b>Wheel Base</b>	<b>Proto:48</b>			<b>Proto:64</b>			<b>Proto:87</b>		
<b>Proto Feet</b>	<b>Model Inches</b>	<b>Off-Set Inches</b>	<b>MIN Curve Inches</b>	<b>Model Inches</b>	<b>Off-Set Inches</b>	<b>MIN Curve Inches</b>	<b>Model Inches</b>	<b>Off-Set Inches</b>	<b>MIN Curve Inches</b>
13	3.250	0.034	38.57	2.438	0.030	24.62	1.791	0.024	16.75
14	3.500	0.036	43.15	2.625	0.031	27.69	1.929	0.025	18.88
15	3.750	0.037	47.85	2.813	0.032	30.85	2.067	0.025	21.09
16	4.000	0.038	52.65	3.000	0.033	34.11	2.204	0.026	23.36
17	4.250	0.039	57.54	3.188	0.034	37.44	2.342	0.027	25.68
18	4.500	0.041	62.52	3.375	0.035	40.84	2.480	0.027	28.07
19	4.750	0.042	67.57	3.563	0.036	44.32	2.618	0.028	30.51
20	5.000	0.043	72.70	3.750	0.037	47.85	2.755	0.029	32.99
21	5.250	0.044	77.88	3.938	0.038	51.44	2.893	0.029	35.52
22	5.500	0.046	83.13	4.125	0.039	55.09	3.031	0.030	38.10
23	5.750	0.047	88.43	4.313	0.040	58.78	3.169	0.031	40.71
24	6.000	0.048	93.77	4.500	0.041	62.52	3.307	0.032	43.36
25	6.250	0.049	99.17	4.688	0.041	66.30	3.444	0.032	46.04
26	6.500	0.051	104.60	4.875	0.042	70.13	3.582	0.033	48.75
<b>1/2% lateral flex chassis with a nominal wheelset as practical option only w/MIN Gage</b>									

**Table 3** provides a median track gage widening (one half allowable) and the same ½ percent wheelbase flexibility and nominal wheel set gage. This table represents the more ideal nominal case for operating equipment reliably and on curves not guarded through special trackwork.

<b>Table 3 Nominal Criteria</b>									
<b>Wheel Base</b>	<b>Proto:48</b>			<b>Proto:64</b>			<b>Proto:87</b>		
<b>Proto Feet</b>	<b>Model Inches</b>	<b>Off-Set Inches</b>	<b>MIN Curve Inches</b>	<b>Model Inches</b>	<b>Off-Set Inches</b>	<b>MIN Curve Inches</b>	<b>Model Inches</b>	<b>Off-Set Inches</b>	<b>MIN Curve Inches</b>
13	3.250	0.047	27.97	2.438	0.040	18.50	1.791	0.031	12.97
14	3.500	0.049	31.60	2.625	0.041	20.96	1.929	0.032	14.71
15	3.750	0.050	35.36	2.813	0.042	23.53	2.067	0.032	16.53
16	4.000	0.051	39.24	3.000	0.043	26.18	2.204	0.033	18.41
17	4.250	0.052	43.24	3.188	0.044	28.93	2.342	0.034	20.36
18	4.500	0.054	47.34	3.375	0.045	31.75	2.480	0.034	22.36
19	4.750	0.055	51.54	3.563	0.046	34.65	2.618	0.035	24.43
20	5.000	0.056	55.83	3.750	0.047	37.62	2.755	0.036	26.54
21	5.250	0.057	60.21	3.938	0.048	40.66	2.893	0.036	28.71
22	5.500	0.059	64.67	4.125	0.049	43.77	3.031	0.037	30.93
23	5.750	0.060	69.20	4.313	0.050	46.93	3.169	0.038	33.19
24	6.000	0.061	73.80	4.500	0.051	50.15	3.307	0.039	35.49
25	6.250	0.062	78.47	4.688	0.051	53.42	3.444	0.039	37.83
26	6.500	0.064	83.20	4.875	0.052	56.75	3.582	0.040	40.21
<b>1/2% lateral flex chassis with a Nominal Wheelset with Nominal Gage Widening</b>									

**Table 4** gives the design maximum limits of curvature compression by allowing absolute maximum gage widening and the aforementioned chassis flexibility improvements. Because of the ‘extreme’ limits of this set of conditions, slow order operations, as required by the prototype, will be required for model operations as well.

<b>Table 4 Maximum Allowable Criteria (Reduced Speed)</b>									
<b>Wheel Base</b>	<b>Proto:48</b>			<b>Proto:64</b>			<b>Proto:87</b>		
<b>Proto Feet</b>	<b>Model Inches</b>	<b>Off-Set Inches</b>	<b>MIN Curve Inches</b>	<b>Model Inches</b>	<b>Off-Set Inches</b>	<b>MIN Curve Inches</b>	<b>Model Inches</b>	<b>Off-Set Inches</b>	<b>MIN Curve Inches</b>
13	3.250	0.060	21.94	2.438	0.050	14.82	1.791	0.038	10.58
14	3.500	0.062	24.93	2.625	0.051	16.87	1.929	0.039	12.05
15	3.750	0.063	28.04	2.813	0.052	19.02	2.067	0.039	13.59
16	4.000	0.064	31.28	3.000	0.053	21.25	2.204	0.040	15.20
17	4.250	0.065	34.64	3.188	0.054	23.57	2.342	0.041	16.86
18	4.500	0.067	38.10	3.375	0.055	25.97	2.480	0.041	18.59
19	4.750	0.068	41.66	3.563	0.056	28.45	2.618	0.042	20.37
20	5.000	0.069	45.32	3.750	0.057	31.00	2.755	0.043	22.21
21	5.250	0.070	49.08	3.938	0.058	33.62	2.893	0.043	24.09
22	5.500	0.072	52.92	4.125	0.059	36.31	3.031	0.044	26.03
23	5.750	0.073	56.84	4.313	0.060	39.06	3.169	0.045	28.01
24	6.000	0.074	60.85	4.500	0.061	41.87	3.307	0.046	30.04
25	6.250	0.075	64.93	4.688	0.061	44.74	3.444	0.046	32.11
26	6.500	0.077	69.07	4.875	0.062	47.66	3.582	0.047	34.21
<b>1/2% lateral flex chassis with a Nominal Wheelset with Maximum Gage Widening</b>									

### Self Guarding Frogs

The tables of dimensions for self guarding frogs are shown below:

<b>Self Guarding Frog Off-Set</b>								
<b>Scale</b>	<b>SG-Frog Off-Set</b>		<b>Recommended</b>		<b>FIT</b>	<b>F MIN</b>	<b>N MAX</b>	<b>W MIN</b>
	<b>MIN</b>	<b>MAX</b>	<b>MAX</b>	<b>+0 / -0.001</b>				
20.3	0.196	0.203	0.203	+0 - .001	0.000	0.086	0.282	0.203
32	0.124	0.130	0.130	+0 - .001	0.000	0.056	0.180	0.130
48	0.083	0.087	0.087	+0 - .001	0.000	0.037	0.120	0.087
64	0.064	0.066	0.066	+0 - .001	0.001	0.029	0.092	0.067
87.1	0.048	0.050	0.050	+0 - .001	0.001	0.022	0.069	0.051
<b>Self Guarding Frog Off-Set MIN = (N-max Less F-min) plus FIT</b>								
<b>Self Guarding Frog Off-Set MAX = W-min Less FIT</b>								
Self guarding frog off-set is the measurement from the inside railhead at the frog point across the frog point railhead to the bearing edge of the guard which presses the wheel front face away from the point rail to insure the wheel flange is away from the railhead side and does not allow a binding of the wheel back flange against the wing rail in the frog flangeway.								



## Section 5 – Organizations

¼" AAR Enthusiasts – **Proto:48**

[www.proto48.org](http://www.proto48.org)

Yahoo Subscribe: [Proto48-subscribe@yahoogroups.com](mailto:Proto48-subscribe@yahoogroups.com)

National Association of S Gaugers – **Proto:64**

<http://www.trainweb.org/proto64/introduction.htm>

Yahoo Subscribe: [Proto64-subscribe@yahoogroups.com](mailto:Proto64-subscribe@yahoogroups.com)

Proto:87 Special Interest Group – **Proto:87**

<http://www.proto87.org/>

Yahoo Subscribe: [proto87-subscribe@yahoogroups.com](mailto:proto87-subscribe@yahoogroups.com)

1:64n42 Fine Scale – **Proto:64n42**

Yahoo Subscribe: [finescale64-subscribe@yahoogroups.com](mailto:finescale64-subscribe@yahoogroups.com)

fiNescale (N and Nn3) – **Fine N and Nn3**

[http://home.t-online.de/home/finescale.n/fs\\_eng.htm](http://home.t-online.de/home/finescale.n/fs_eng.htm)

<http://www.2mm.org.uk/>

<http://www.nn3.org/>

Yahoo Subscribe: [nn3-subscribe@yahoogroups.com](mailto:nn3-subscribe@yahoogroups.com)

Standard S3.1 Trackwork

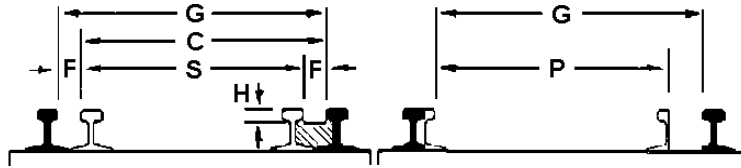

TR10-2003 Name of Scale	G Track Gage		C Check Gage		S Span		F Flangeway Frog		F Flangeway Guard	H Flange Depth	P Switchpoint Spread	R Railhead Radius	
	Min	Max	Min	Max	Min	Max	Min	Max	Nominal	Min	Max	Min	Max
	Inch	mm	Inch	mm	Inch	mm	Inch	mm	Inch	mm	Inch	mm	Inch
<b>Proto:20.3</b>	2.783	2.845	2.685	2.722	2.571	2.599	0.086	0.092	0.099	0.062	2.549	0.018	0.028
	70.69	72.26	68.19	69.13	65.30	66.00	2.19	2.35	2.50	1.56	64.75	0.47	0.70
<b>Proto:20.3n3</b>	1.773	1.835	1.675	1.712	1.561	1.589	0.086	0.092	0.099	0.062	1.539	0.018	0.028
	45.04	46.61	42.54	43.48	39.65	40.35	2.19	2.35	2.50	1.56	39.10	0.47	0.70
<b>Proto:32</b>	1.766	1.805	1.703	1.727	1.630	1.647	0.056	0.059	0.063	0.039	1.617	0.012	0.018
	44.85	45.84	43.26	43.85	41.40	41.84	1.41	1.49	1.59	0.99	41.08	0.30	0.45
<b>Proto:32n3</b>	1.125	1.164	1.063	1.086	0.989	1.007	0.056	0.059	0.063	0.039	0.977	0.012	0.018
	28.58	29.57	26.99	27.58	25.13	25.57	1.41	1.49	1.59	0.99	24.80	0.30	0.45
<b>Proto:48</b>	1.177	1.203	1.135	1.151	1.086	1.098	0.037	0.039	0.042	0.026	1.078	0.008	0.012
	29.90	30.56	28.84	29.24	27.59	27.89	0.95	0.99	1.06	0.66	27.38	0.20	0.30
<b>Proto:48n3</b>	0.750	0.776	0.708	0.724	0.659	0.671	0.037	0.039	0.042	0.026	0.651	0.008	0.012
	19.05	19.71	17.99	18.39	16.74	17.04	0.95	0.99	1.06	0.66	16.54	0.20	0.30
<b>Proto:64</b>	0.883	0.902	0.851	0.864	0.813	0.822	0.029	0.030	0.031	0.020	0.809	0.006	0.009
	22.42	22.92	21.60	21.95	20.66	20.88	0.75	0.77	0.79	0.50	20.54	0.15	0.22
<b>Proto:64n3</b>	0.563	0.582	0.530	0.544	0.493	0.502	0.029	0.030	0.031	0.020	0.488	0.006	0.009
	14.29	14.78	13.47	13.82	12.53	12.75	0.75	0.77	0.79	0.50	12.40	0.15	0.22
<b>Proto:87</b>	0.649	0.663	0.625	0.635	0.597	0.604	0.022	0.023	0.023	0.014	0.594	0.004	0.006
	16.48	16.84	15.87	16.14	15.17	15.33	0.56	0.57	0.58	0.36	15.09	0.11	0.16
<b>Proto:87n3</b>	0.413	0.428	0.389	0.400	0.362	0.368	0.022	0.023	0.023	0.014	0.359	0.004	0.006
	10.50	10.86	9.89	10.16	9.19	9.35	0.56	0.57	0.58	0.36	9.11	0.11	0.16
<b>Fine Scale Options</b>													
Name of Scale	G Track Gage		C Check Gage		S Span		F Flangeway Frog		F Flangeway Guard	H Flange Depth	P Switchpoint Spread		
	Min	Max	Min	Max	Min	Max	Min	Max	Nominal	Min	Max	Min	Max
	Inch	mm	Inch	mm	Inch	mm	Inch	mm	Inch	mm	Inch	mm	Inch
<b>Fine:HO</b>	0.649	0.665	0.613		0.580		0.040		0.040	0.026	0.605		
	16.5	16.9	15.6		14.7		1.0		1.0	0.7	15.4		
<b>Fine:HO n3</b>	0.413	0.429	0.377		0.343		0.040		0.040	0.026	0.369		
	10.5	10.9	9.6		8.7		1.0		1.0	0.7	9.4		
<b>Fine:TT</b>	0.471	0.485	0.441		0.414		0.033		0.033	0.022	0.430		
	12.0	12.3	11.2		10.5		0.8		0.8	0.6	10.9		
<b>Fine:TT n3</b>	0.300	0.314	0.270		0.243		0.033		0.033	0.022	0.259		
	7.6	8.0	6.9		6.2		0.8		0.8	0.6	6.6		
<b>Fine:N</b>	0.354	0.360	0.340		0.315		0.025		0.025	0.025	0.327		
	9.0	9.1	8.6		8.0		0.6		0.6	0.6	8.3		
<b>Fine:N n3</b>	0.250	0.256	0.229		0.205		0.025		0.025	0.025	0.219		
	6.4	6.5	5.8		5.2		0.6		0.6	0.6	5.6		

**NOTES:**

1. See Tech-Note TN-1.1.1 (Proto and Fine) for a more detail on the Proto Scale dimensions and issues related to building in Proto and Fine scale.
2. Switch Point Max (Electrical) is not required in Proto:Scale due to the ample Mechanical clearance provided.

Standard S4.1 Wheels

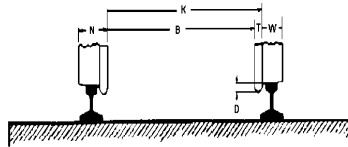

TR10-2003		K		B		N		T		D		WHEEL GAGE	
Name of Scale		Wheel Check Gage		Back to Back		Wheel Width		Flange Width		Flange Depth		note 5	
		Min	Max	Min	Max	Min	Max	Min	Max	Min	Max	Min	Max
Proto:20.3	Inch	2.665	2.685	2.608	2.629	0.271	0.282	0.057	0.068	0.049	0.062	2.722	2.765
	mm	67.68	68.19	66.24	66.78	6.88	7.16	1.45	1.72	1.25	1.56	69.13	70.23
Proto:20.3n3	Inch	1.655	1.675	1.598	1.619	0.271	0.282	0.057	0.068	0.049	0.062	1.712	1.755
	mm	42.03	42.54	40.59	41.13	6.88	7.16	1.45	1.72	1.25	1.56	43.48	44.58
Proto:32	Inch	1.690	1.702	1.654	1.668	0.172	0.180	0.036	0.042	0.031	0.039	1.727	1.752
	mm	42.94	43.23	42.02	42.37	4.37	4.56	0.92	1.07	0.79	0.99	43.85	44.50
Proto:32n3	Inch	1.050	1.062	1.014	1.027	0.172	0.180	0.036	0.042	0.031	0.039	1.086	1.111
	mm	26.66	26.96	25.75	26.09	4.37	4.56	0.92	1.07	0.79	0.99	27.58	28.23
Proto:48	Inch	1.127	1.134	1.103	1.112	0.115	0.120	0.024	0.028	0.021	0.026	1.151	1.167
	mm	28.62	28.81	28.01	28.24	2.91	3.05	0.61	0.70	0.53	0.66	29.24	29.65
Proto:48n3	Inch	0.700	0.707	0.676	0.685	0.115	0.120	0.024	0.028	0.021	0.026	0.724	0.740
	mm	17.78	17.97	17.16	17.40	2.91	3.05	0.61	0.70	0.53	0.66	18.39	18.80
Proto:64	Inch	0.845	0.849	0.828	0.834	0.087	0.092	0.017	0.019	0.017	0.020	0.862	0.873
	mm	21.47	21.55	21.03	21.18	2.21	2.35	0.43	0.49	0.42	0.50	21.90	22.17
Proto:64n3	Inch	0.525	0.528	0.508	0.514	0.087	0.092	0.017	0.019	0.017	0.020	0.542	0.553
	mm	13.33	13.42	12.90	13.05	2.21	2.35	0.43	0.49	0.42	0.50	13.77	14.04
Proto:87	Inch	0.621	0.623	0.609	0.613	0.064	0.069	0.012	0.014	0.012	0.014	0.633	0.640
	mm	15.77	15.82	15.46	15.57	1.63	1.74	0.31	0.35	0.32	0.36	16.09	16.27
Proto:87n3	Inch	0.386	0.387	0.373	0.377	0.064	0.069	0.012	0.014	0.012	0.014	0.398	0.405
	mm	9.80	9.84	9.48	9.59	1.63	1.74	0.31	0.35	0.32	0.36	10.11	10.29
Fine Scale Options													
Name of Scale		K		B		N		T		D		WHEEL GAGE	
		Wheel Check Gage		Back to Back		Wheel Width		Flange Width		Flange Depth		note 5	
Fine:HO	Inch	0.613		0.581		0.086		0.025		0.023		0.638	
	mm	15.6		14.8		2.2		0.6		0.6		16.2	
Fine:HO n3	Inch	0.377		0.345		0.086		0.025		0.023		0.402	
	mm	9.6		8.8		2.2		0.6		0.6		10.2	
Fine:TT	Inch	0.441		0.415		0.071		0.020		0.022		0.461	
	mm	11.2		10.5		1.8		0.5		0.6		11.7	
Fine:TT n3	Inch	0.270		0.244		0.071		0.020		0.022		0.290	
	mm	6.9		6.2		1.8		0.5		0.6		7.4	
Fine:N	Inch	0.336		0.323		0.051		0.013		0.017		0.349	
	mm	8.5		8.2		1.3		0.3		0.4		8.9	
Fine:N n3	Inch	0.228		0.215		0.051		0.013		0.017		0.241	
	mm	5.8		5.5		1.3		0.3		0.4		0.3	

NOTES:

1. See Tech Note TN-1.1.1 (Proto and Fine) for more detail on the Proto Scale dimensions and issues related to building in Proto and Fine Scale.
2. Options of Proto:Scale wheel profiles are provided in the Tech Note.
3. Tread Taper is 1:20 for all profiles.
4. Tread Taper and Fillet Radius are not optional – but are required for Proto:Scales.
5. Wheel Gage is from facing flange gage point to facing flange gage point (K+T).